

# Data Sheet



Article number: 03445050

Description: Fluro Heavy Duty Spherical Plain Bearing GE 50 EW-2RS  
Hole Ø50

Note: 50

## Measures

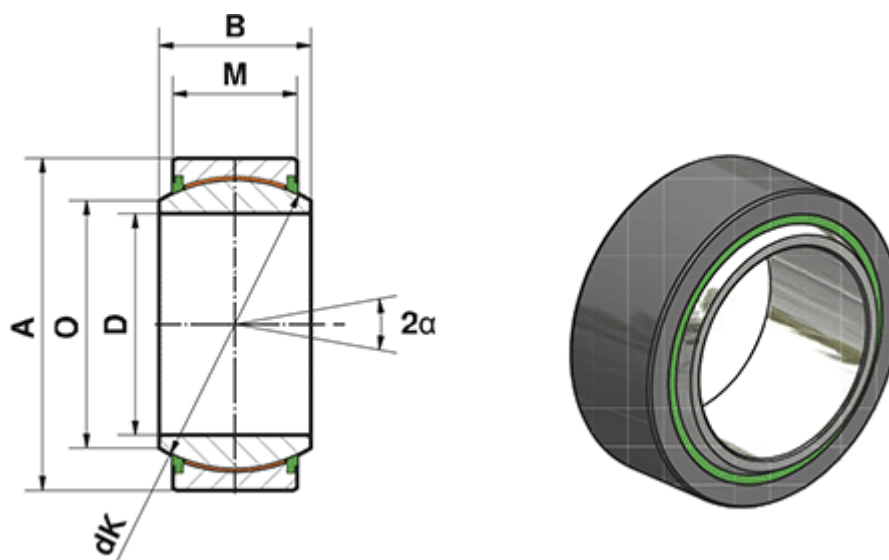

A	= 75	Static load C0 (kN) = 737
a (degrees)	= 6	Weight (g) = 530
B	= 35	
D	= 50	
dk	= 66	
Dynamic load C (kN)	= 442	
M	= 28	
O	= 55.9	